

 Druckgießformen  Dies for pressure die-casting  Stampi per pressofusione

CM EUROPA STAMPI





Erosione Electroerosion Erosion

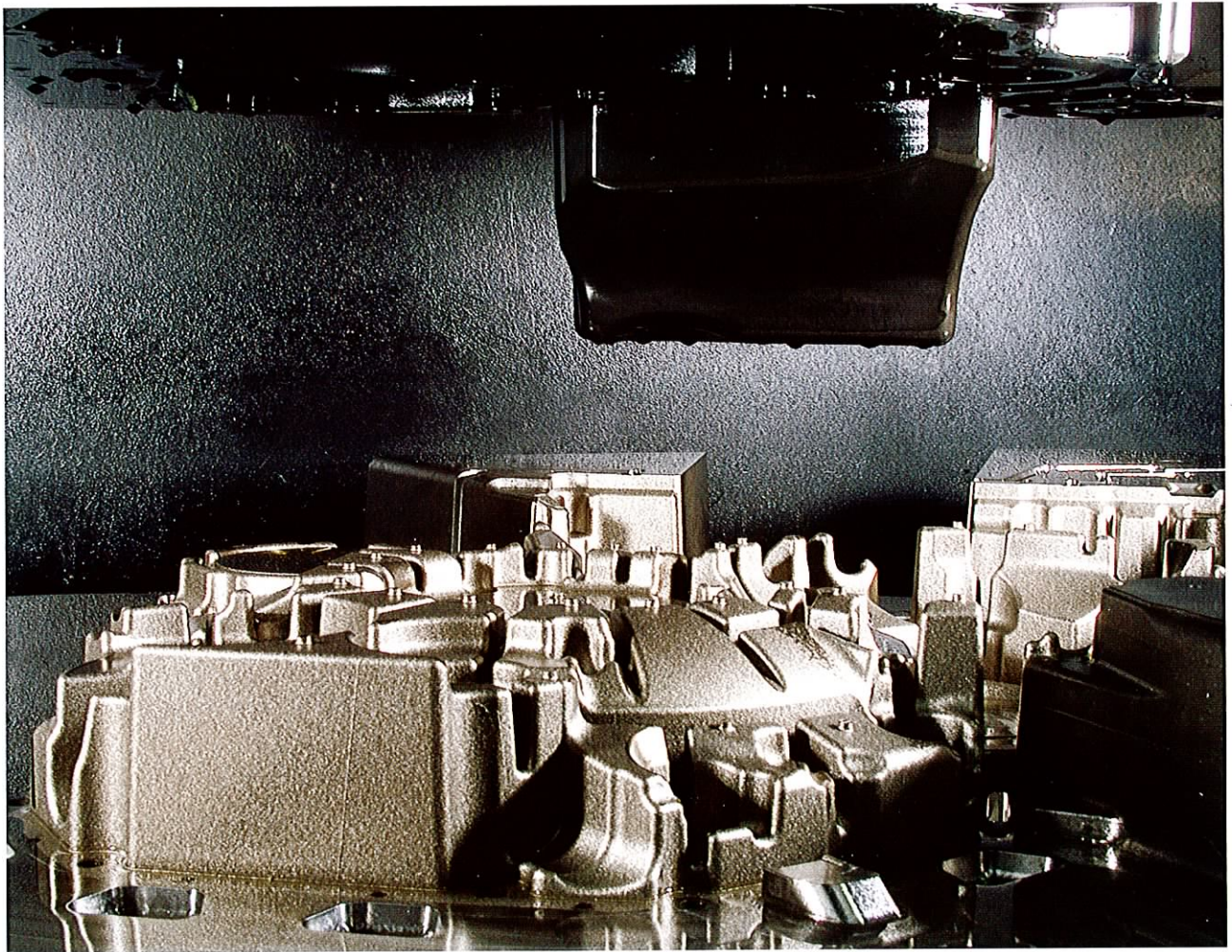

 **CM Europa Stampi utilizza sistemi di erosione a tuffo e filo per garantire precisione e rapidità di esecuzione.**

 **CM Europa Stampi uses sparkle and wire-cut EDM to guarantee precise and rapid execution.**

 **CM Europa Stampi verfügt über Senk- und Drahterodiersystemen, die Präzision und Geschwindigkeit gewährleisten.**

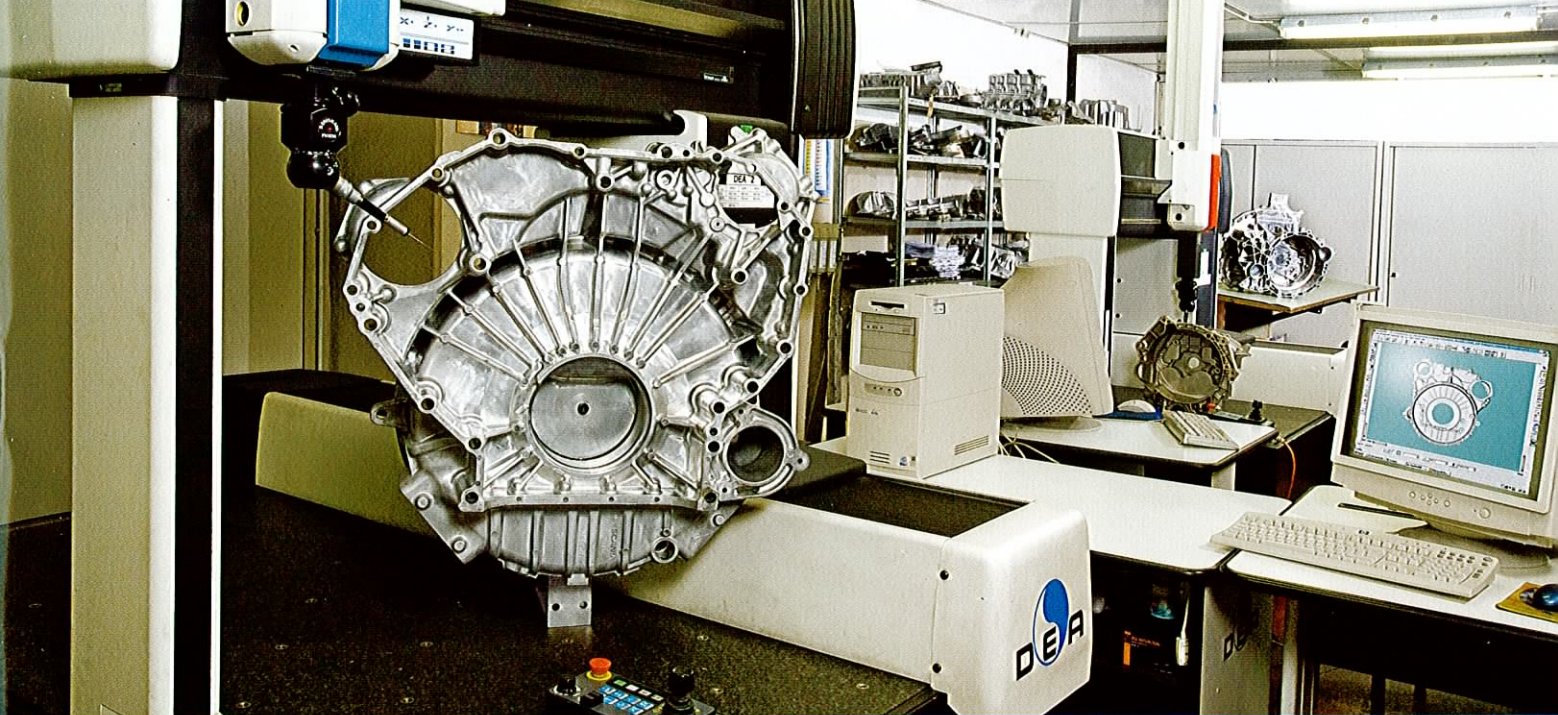

Qualità Quality Qualität

 I controlli e collaudi sono effettuati in modo continuo e totale su tutti i particolari di nostra produzione con l'ausilio di macchinari per controllo 3D e software dedicati al collaudo elettrodi e matematiche.

 We continuously conduct comprehensive checks and testing of all the parts we make, using 3D control machinery and dedicated software for electrode and 3D-Model testing.

 Alle hergestellten Teile sind ständigen und völligen Kontrollen und Prüfungen durch 3D Maschinen und Software zur Elektroden- und mathematischen Prüfung unterworfen.

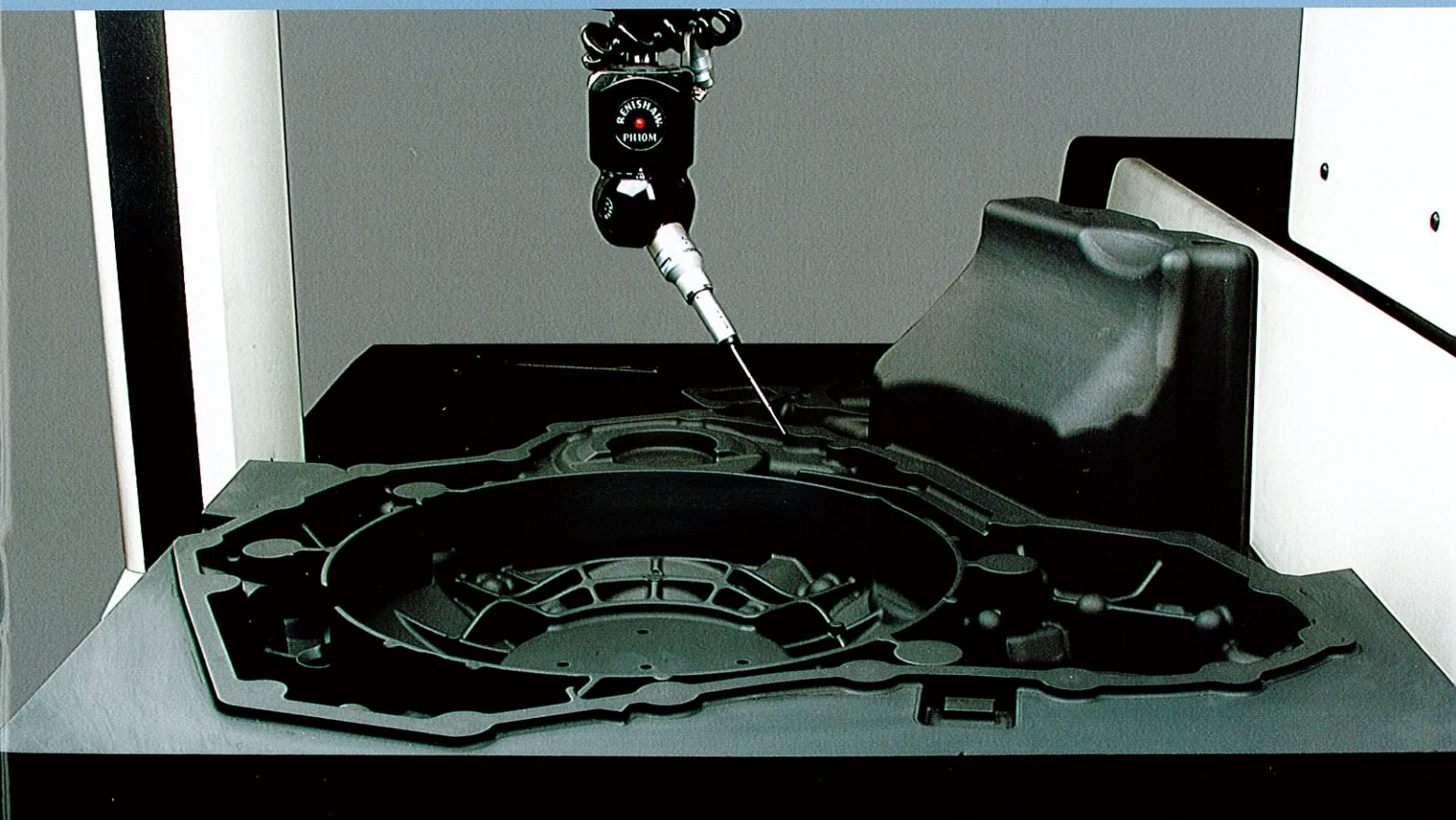

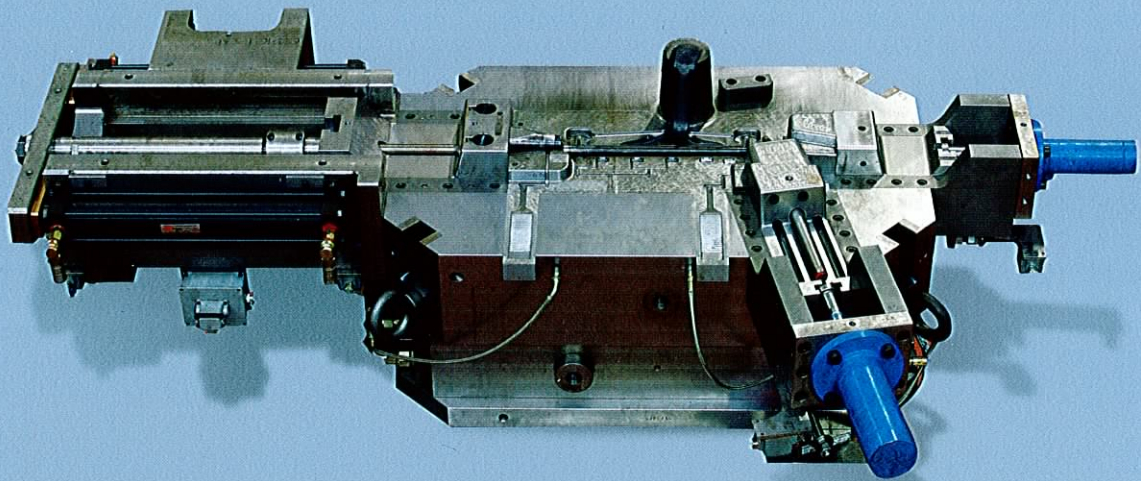

Stampi per pressofusione Dies for pressure die-casting Druckgießformen

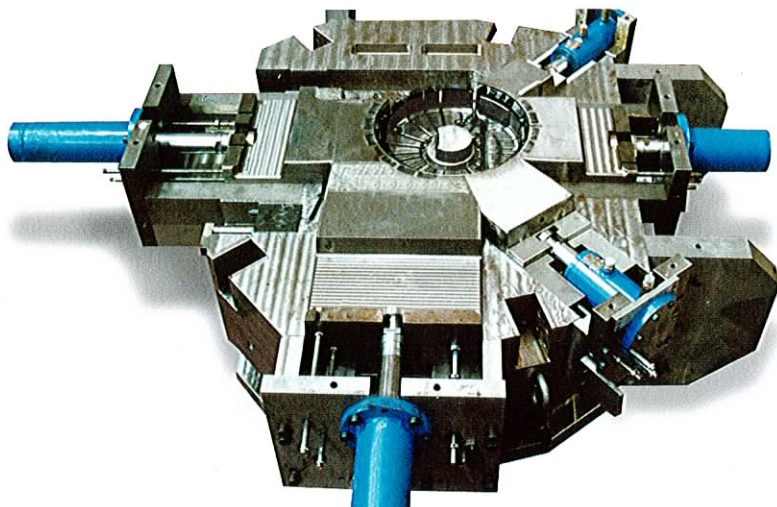
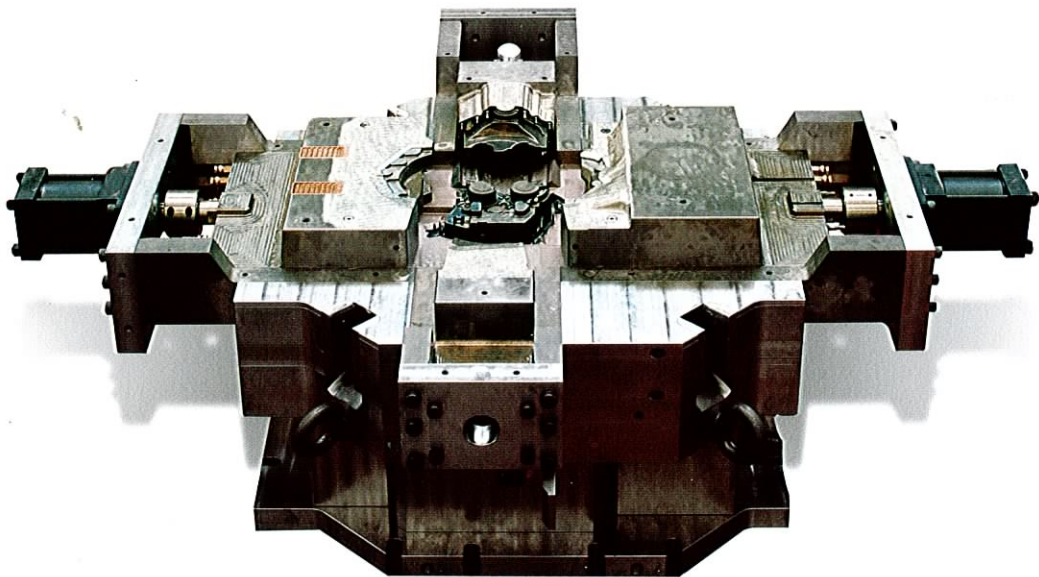

 **Stampo per tubo sterzo**
Pressa 1300 Ton
Stampo scatola cambio
Pressa 1600 Ton
Stampo scatola ventola
Pressa 2500 Ton

 Die for steering housing,
 1300-ton die casting presses
 Die for gearbox,
 1600-ton die casting presses
 Die for flywheel housing,
 2500-ton die casting presses

 Form für Lenkgehäuse
 Giessmaschine 1300 Tonnen
 Form für Getriebegehäuse
 Giessmaschine 1600 Tonnen
 Form für Schwungradgehäuse
 Giessmaschine 2500 Tonnen

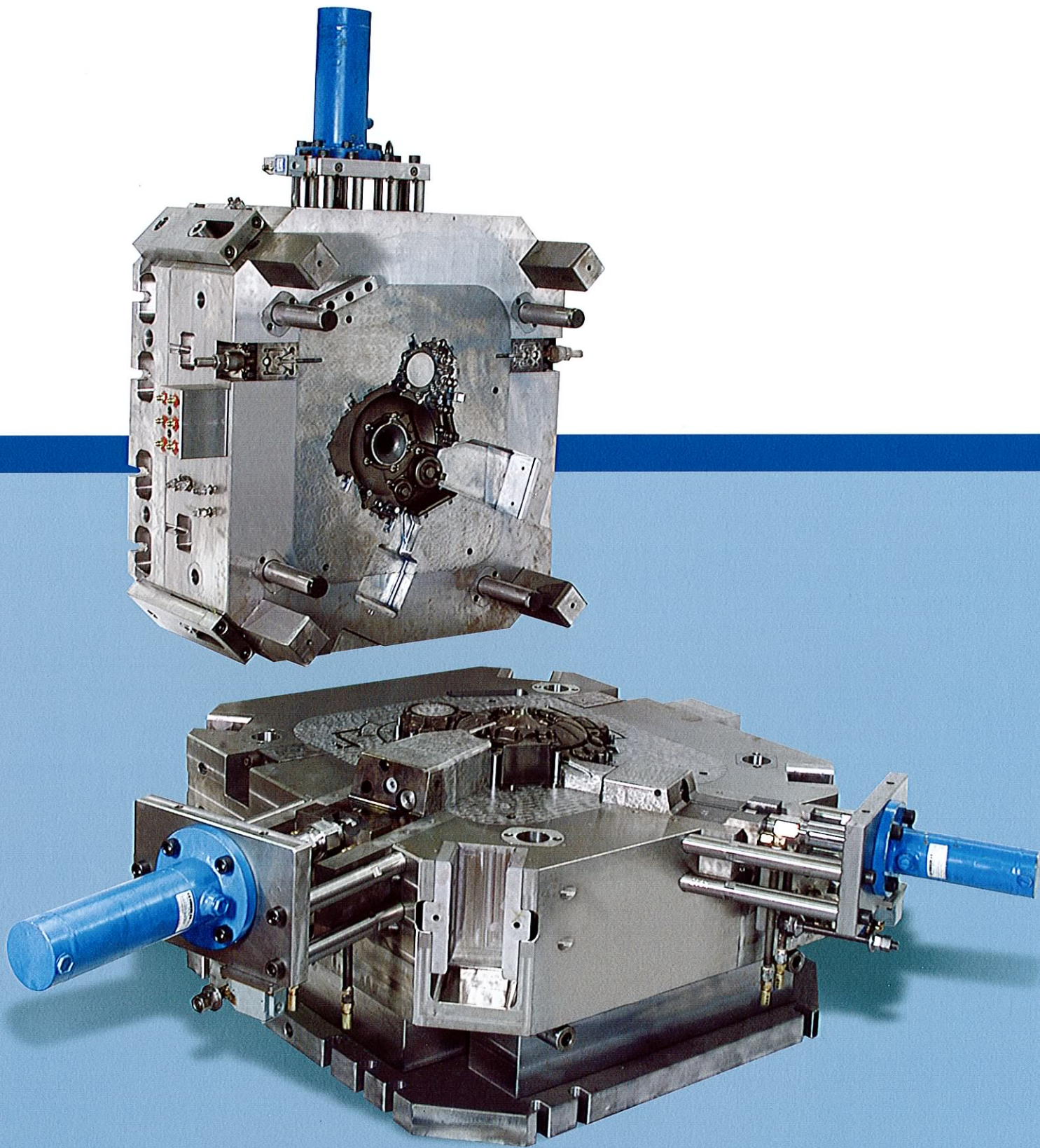

 Coperchio motore
Pressa 2000 Ton

 Bearing housing,
2000 Ton-die casting presses

 Achsenlagergehäuse
Giessmaschine 2000 Tonnen

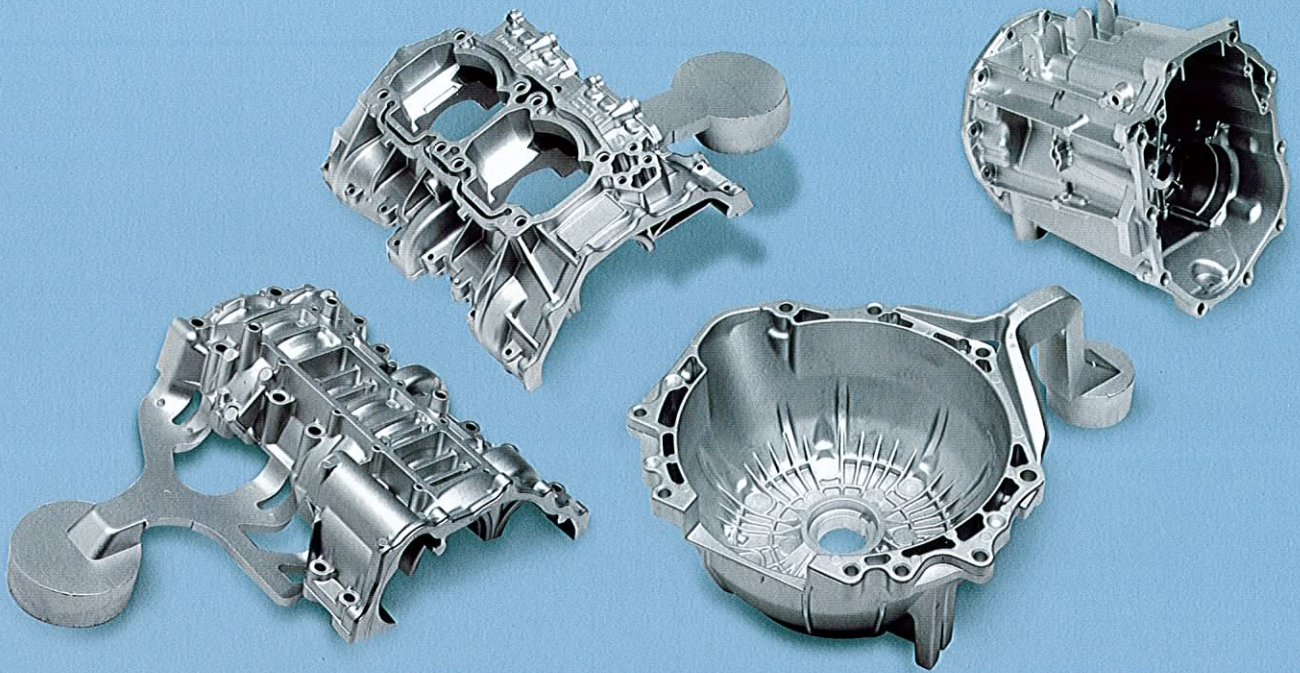

Prodotti Products Produkte



 Particolari per settore
automotive, elettronica,
telecomunicazione
e settore casalinghi.

 Parts for the automotive,
electronics and
telecommunications industries
and for household products.

 Teile für viele
Anwendungsbereiche:
Automobilindustrie, Elektronik,
Telekommunikation und Haushalt.

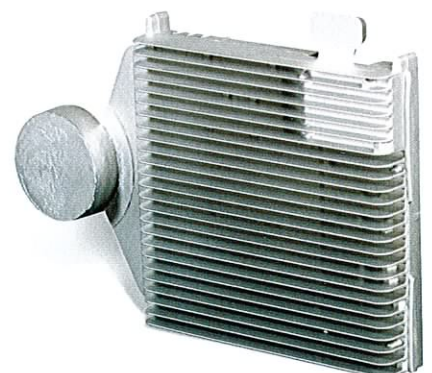

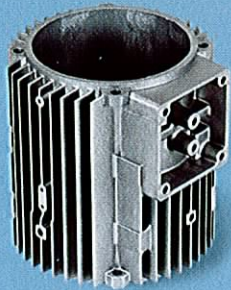
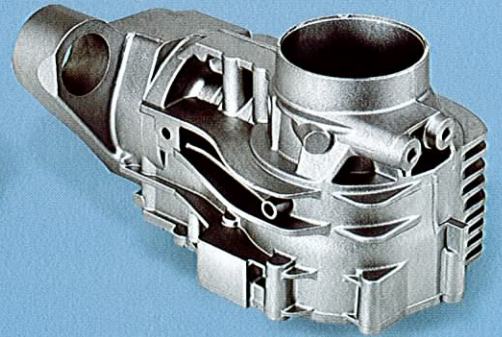
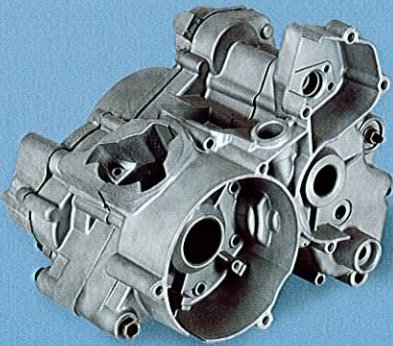
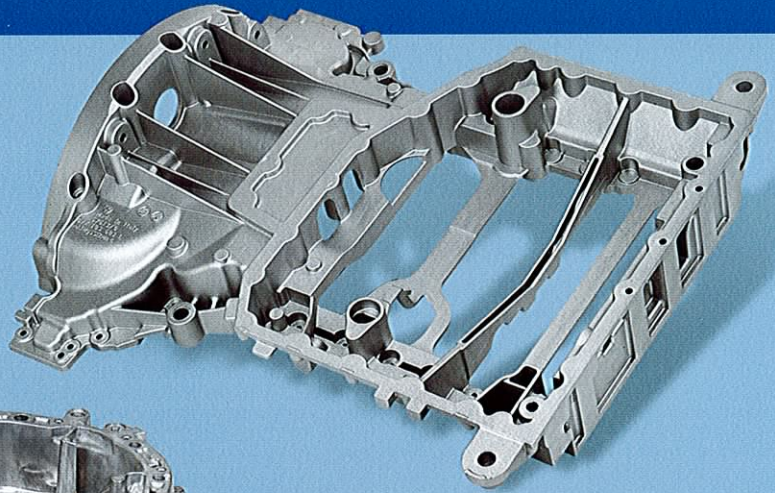
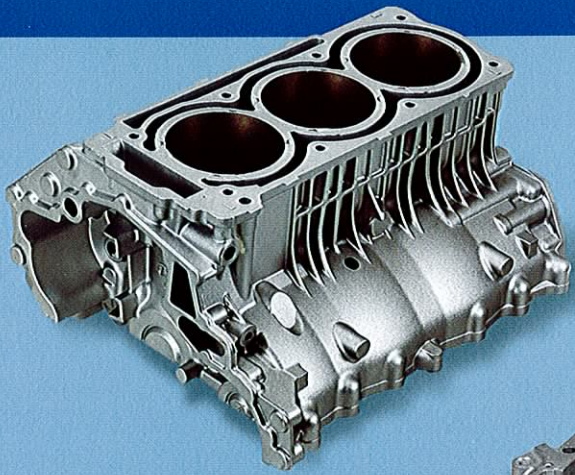
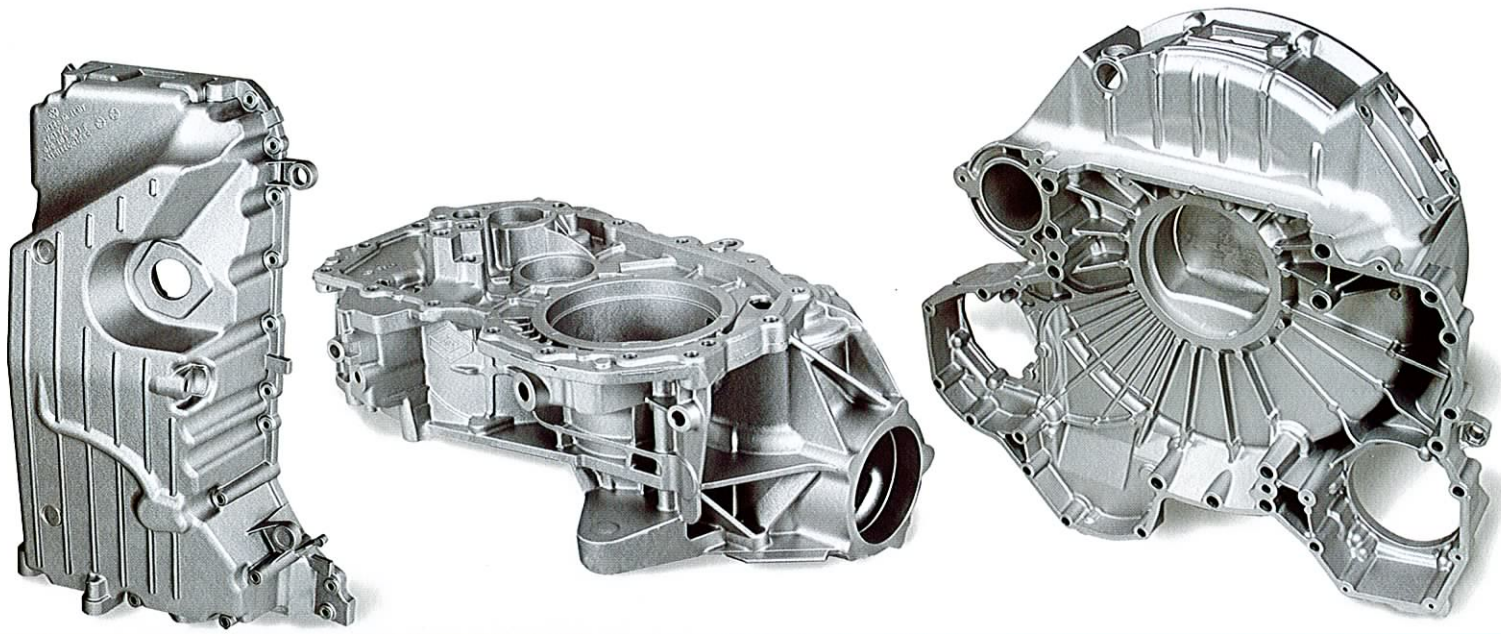



EUROPA STAMPI

via Torretta 50
40012 Calderara di Reno
Bologna - Italia
tel. +39 051 729277
+39 051 729263
fax +39 051 729267
info@cmeuropastampi.it
www.cmeuropastampi.it